

# Atlas Copco

High-pressure oil-free air compressors  
ZD 800-1200 & ZD 1200 VSD air-cooled



*Sustainable Productivity*



# A 40 bar air-cooled compressor: No cooling tower required

At 40 bar, most compressors are water-cooled. But water is a valuable, expensive resource. An excellent alternative is Atlas Copco's ZD air-cooled compressor.



## PET bottles

Sustainability is key



Blowing PET bottles for the beverage industry demands 100% oil-free air. In addition, sustainability is a major driving force. PET bottles must be manufactured using less water and energy. By providing high-quality compressed air with no water consumption, the ZD air-cooled compressor is your sustainable partner.

## Food containers

Flexibility for all sizes



Innovations in PET are leading to its increasing use for food containers. High-quality compressed air is essential for the production process. The ZD's flexibility to cope with different sizes and shapes of containers makes it the perfect fit for the food industry.

## Non-food containers

Adherence to strict regulations



Pharmaceuticals and cosmetics depend on high-purity compressed air, which is guaranteed by the Class 0 rated ZD compressor. Well adapted to smaller packages and flows, with simplified installation without the need of a costly cooling system, the ZD is ideal for the pharma industry.

## New technologies

Sustainability for our future



Solar energy, advanced electronics, aeronautics, automotive, non-woven fibers—all these industries rely on a steady, sustainable supply of high-quality, clean compressed air. If you're looking to the future, and have a strong interest in sustainability and preservation of water resources, you need to consider the ZD air-cooled compressor.

## Driving down total costs

Thanks to the ZD air-cooled compressor you can achieve immediate and long-term savings in investment, maintenance, water treatment and water consumption. Combining a highly efficient screw compressor and a world renowned booster gives you the best of each technology, resulting in energy savings whether in fixed speed or variable speed drive versions.

## Keeping your production up and running

Downtime can severely affect your bottom line. A reliable design, with no compromise on components, is the key factor for quality. Atlas Copco's ZD air-cooled compressors produce a reliable supply of compressed air that you can depend on, 24/7.

## Protecting your reputation

It's not only your production that's at stake, but your reputation. By providing high-purity clean air, the ZD can protect your company's reputation in the marketplace, ensure safety and help protect the environment.

## Optimizing your investment by adapting medium & high pressure networks

Combining the medium pressure and high pressure networks separately reduces the investment necessary and cuts energy consumption. Reinjection leads to further savings. ZD, as a flexible configuration, makes all this possible, with significant benefits and savings.

## Easy and safe in the workplace

The ZD is silent, and easy to manage and service, making it greatly appreciated by your operators.

## Assuring your peace of mind

At Atlas Copco, compressed air is our specialty. We invest continuously to ensure a committed, competent service organization. Thanks to our presence in over 170 countries we offer timely, professional service worldwide with 24/7 availability.

# Cumulative savings with air-cooling

By using fans to force ambient air into the compressor canopy, fresh air circulates around the compressor and its internal closed loop cooling system, dissipating heat as it does so.

## Limited investment & pressure losses

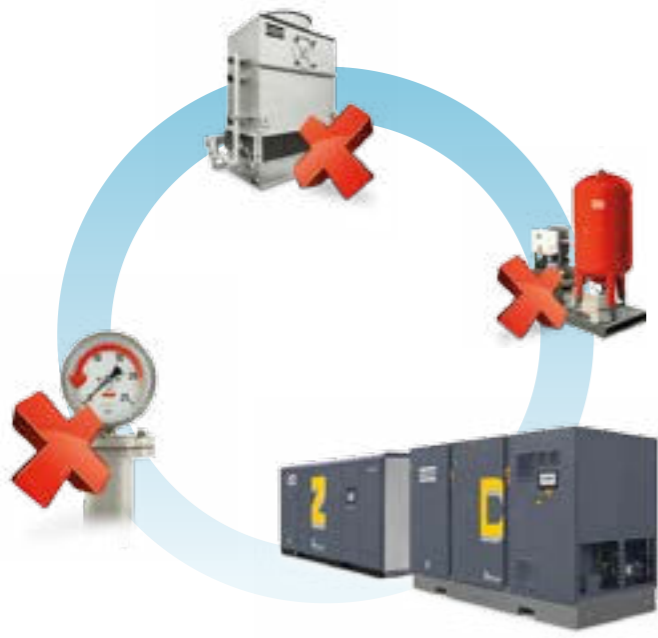

The ZD needs no external cooling circuit. This means **no cooling tower or cooling unit, no water pump skid and no piping**. This immediately and significantly slashes the investment required. In addition, pressure losses are reduced due to less piping in the air network. This is another source of savings.

## Reduced installation costs and handling

An external cooling system is commonly installed on a roof, with an intricate piping system for connection to the compressor. This demands expert handling with expensive hoisting equipment and considerable time spent installing the piping connections. With the ZD air-cooled compressor, you save all this work and the associated costs. Installation is straightforward on your factory floor, in a suitably ventilated place.

## Savings in maintenance

ZD also obviously negates the expenses associated with traditional water cooling systems and procedures – and all the associated maintenance activities:

- No time spent maintaining the cooling system.
- No anti-scaling or antifreeze protection to be added.
- No inspection or cleaning.
- No need to flush/refill the water circuit at specific maintenance intervals.

## The correct air quality

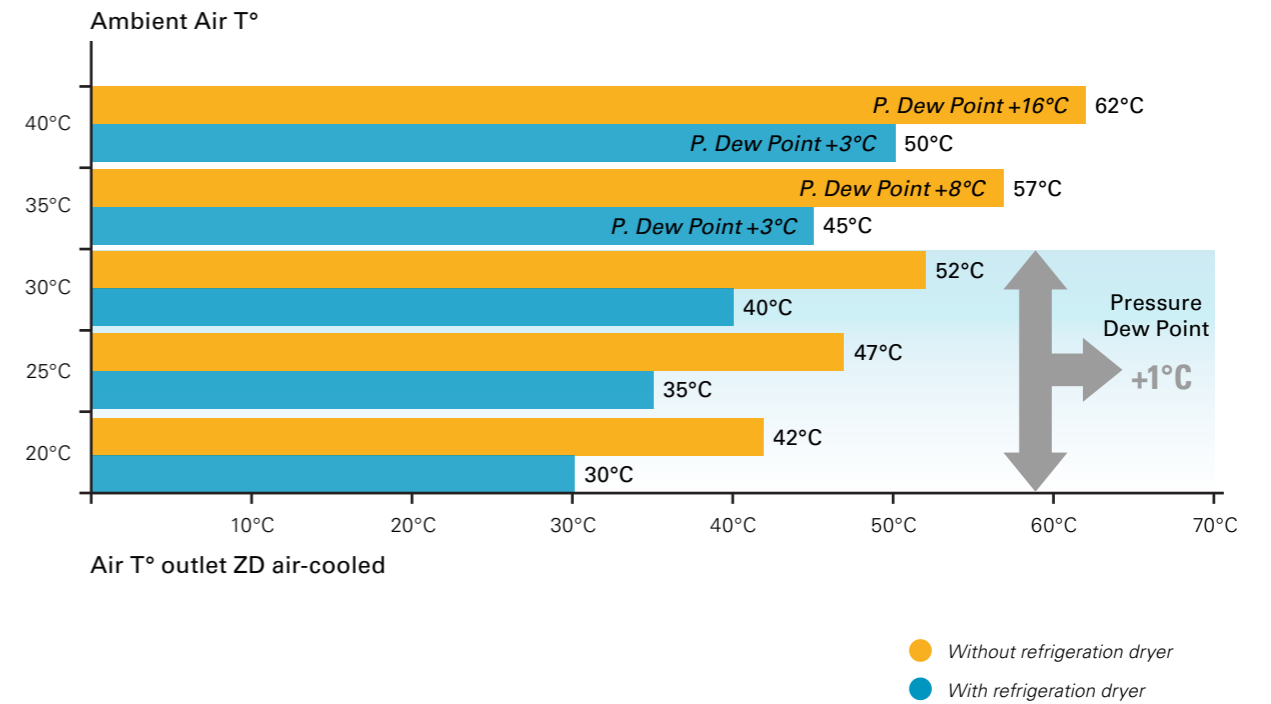

Important factors for processes running downstream from the compressor are the air outlet temperature and the dew point, as these determine the air quality at your blowing equipment inlet.

The graph shows that the difference between the ZD outlet temperature and the atmospheric temperature is +22°C without refrigeration dryer. With the optional refrigeration dryer, the difference is +10°C. If the ambient temperature is above 35°C we advise adding an Atlas Copco HFD refrigeration dryer downstream the ZD.

## Savings in water consumption

The volume of evaporated water in a water-cooled system is huge. It depends on the ambient temperature, but an air-cooled compressor can save you an average of 3 liters per kW/h. With the price of water continuing to increase, these savings will be even higher in the future. Contact us for a precise calculation. To top it off, the ZD helps your company achieve its environmental goals, particularly with regard to its water footprint.





# Reliable in every component

The ZD combines an air-cooled screw compressor and an air-cooled booster. At the heart of the initial stages of compression, the ZT is a highly reliable Atlas Copco screw compressor. It requires little maintenance and is designed to work in all conditions with exceptional durability.



**1** The unique Z-seal design guarantees 100% oil-free air. The quality of the air is Class Zero certified by TÜV authorities. The compressor operates at safe running speeds and there is no contact between the rotors.



**2** Totally enclosed, high efficiency motor:  
 • IP55 TEFC protection against dust and humidity.



**3** Regeneration cooler – Highly efficient, ultra-reliable air-cooling based around stainless steel pre-cooler with fans:  
 • Excellent heat transfer.  
 • Low energy cooling fans.  
 • Easy access for cleaning.



**4** The adsorption dryer integrated inside the Z-canopy operates on heat compression and has negligible power consumption. It supplies dry air to the booster downstream.



The Elektronik® control and monitoring system allows easy dialogue with the equivalent Elektronik® system installed on the booster. All electrical and electronic components and modules are integrated in a specially designed cubicle. All connections are pre-wired.

# Boost your productivity

The reciprocating piston booster operates with extremely high efficiency for high pressures. Thanks to the dryer located at the screw compressor outlet, the booster is condensate-free, thus preserving the internal components for increased reliability.



**1** Compression element:  
 • 100% oil-free compression chambers with PTFE piston rings.  
 • The quality of the air is Class Zero certified by TÜV authorities.



**2** Highly efficient cooling system:  
 • Closed loop cooling in compressor.  
 • No water consumption.



**3** Horizontal design:  
 • Less vibration and reduced wear.  
 • Higher efficiency.  
 • Low centre of gravity, coolers placed at low level.



**4** Fans & radiator:  
 • High quality fans and radiator with aluminum body, ensuring efficient cooling.



**5** High efficiency motor:  
 • Totally enclosed with IP55 TEFC protection against dust and humidity.



All electrical and electronic components and modules are integrated in a specially designed cubicle:  
 • All connections are pre-wired.  
 • Elektronik® monitoring system for management, alarms, safety shutdowns and service indications.  
 • Only one stop-start button for easy operation.

# Oil-free: stress-free

Even sub-micron particles of oil can cause expensive or irreparable damage. In the food & beverage sector, oil contamination can lead to product contamination and ruin your reputation. You therefore need a reliable supply of air close to purity. Oil-free air technology is an excellent solution. ZD oil-free air compressors suit applications such as food & beverage manufacturing that cannot compromise when it comes to 100% oil-free, clean air.

## Can oil-injected compressors with oil removal filters deliver oil-free air?

Using oil filters with a conventional oil-injected air compressor is always risky. Oil removal involves multiple components. If any of these components should fail, the result could be contamination. Even the best filters are incapable of removing all traces of oil – and need frequent maintenance too.

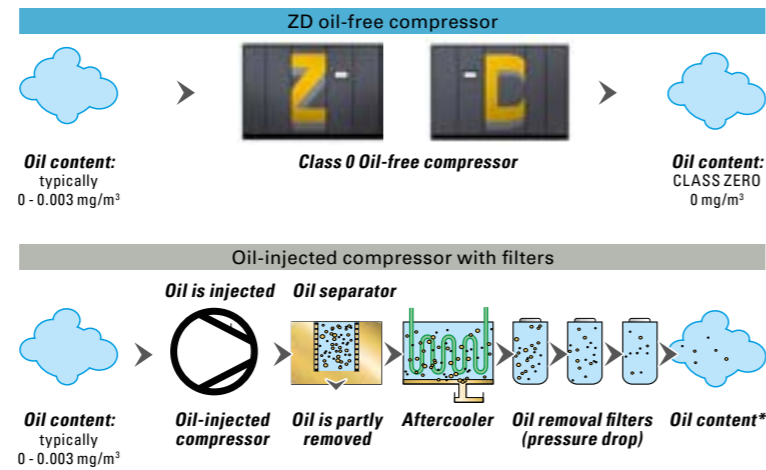

\* If low ambient temperature + clean filters = Class 2 edition 2001 (≤ 0.1 mg/m<sup>3</sup>)  
If high ambient temperature + saturated filters = Class 3 edition 2001 (≤ 1 mg/m<sup>3</sup>)

## Oil-free for savings

With oil-free technology you immediately save the time and cost of maintenance operations and filter changes, and you avoid expensive cleaning of your process in case of accidental contamination.

## Class 0: Certified for the best



Class 0 is the most stringent class as per ISO 8573-1 and guarantees perfectly oil-free air. The ZD compressor has been tested by TÜV and approved as a certified Class 0 compressor. This is the only guarantee of a safe supply of oil-free air.



# Choose ZD and save energy

With energy representing over 70% of a compressor's lifecycle costs, the ZD compressor can help reduce your electricity consumption substantially. The ZD is designed to save energy at every stage of compression.

## By adapting the pressures



The required air pressure depends on the size and shape of the bottles being produced. The pressure can be easily adjusted with the Elektronikon® controller to the required value between 25 bar (362 psig) and 40 bar (580 psig). This cuts electricity consumption by between 5 and 8%.

## By combining screw and piston technologies

In a ZD, the first two stages are based around screw compression technology which is the most commonly used technology for up to 10 bars because it is energy efficient, cost effective and low in maintenance. This leads to 10% extra efficiency during operation.

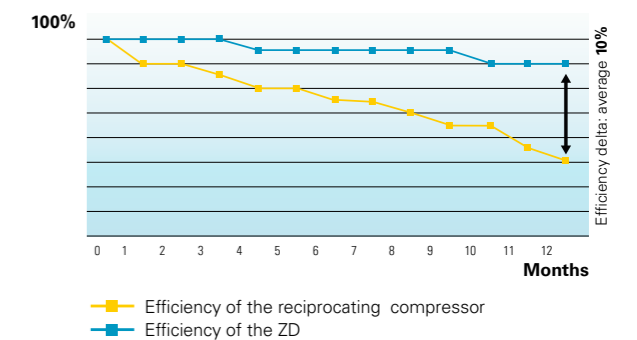

## By compressing dry air

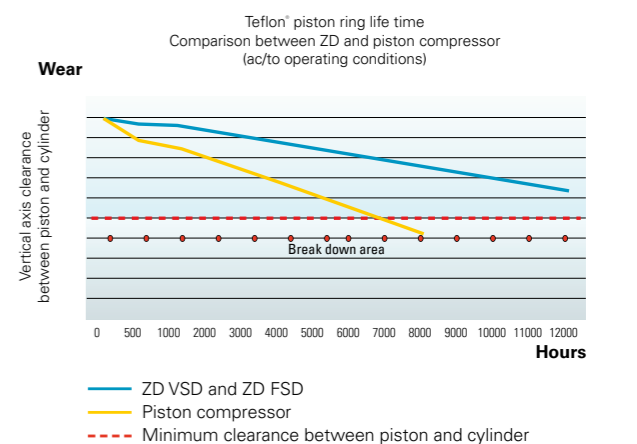

## By design: 4-stage compression

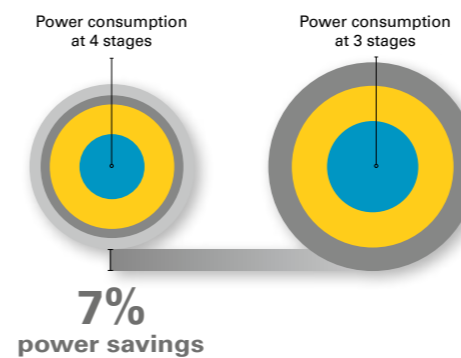

The ZD uses 4-stage configuration, which is 7% more efficient at compressing air than 3-stage configuration. The compression ratio is better and the interstage temperatures are lower. The results are impressive: energy is saved, reliability is enhanced, and maintenance costs are slashed.

The ZD is equipped with a dryer at booster inlet to eliminate condensate. Compared to traditional piston technology, this saves energy and increases the life-time of moving parts (rings, packings, valves).

# Variable Speed Drive: 35% additional savings

Variable Speed Drive is particularly useful in applications where air demand fluctuates significantly – over 90% of all production environments. VSD technology adjusts the motor speed to closely follow the air demand.

## Impressive direct savings

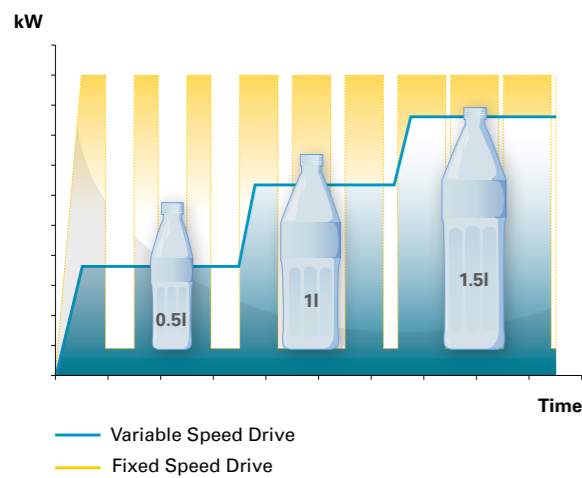

Only true VSD technology can achieve good results. Because Atlas Copco has pioneered VSD technology since 1994, it has built genuine integrated VSD technology:

- The ZD comes as a complete VSD package (screw compressor, dryer and booster).
- The variation span is exceptionally wide, between 40 and 100% of the capacity.

## Choose the right technology

You can easily mix and match fixed speed machines and VSD machines, such as base load with VSD machines and top load with fixed speed machines, or vice versa. Do not hesitate to contact your Atlas Copco representative for the best solution for your process or a complete simulation of the energy savings possible with VSD.

## Additional advantages

### Constant outlet pressure

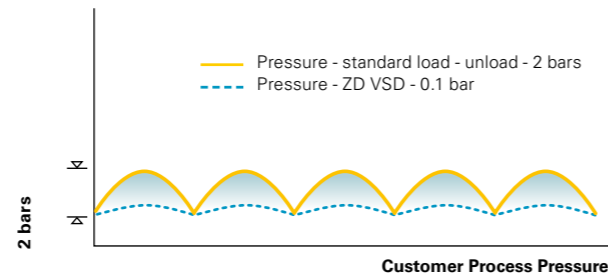

### Low starting current

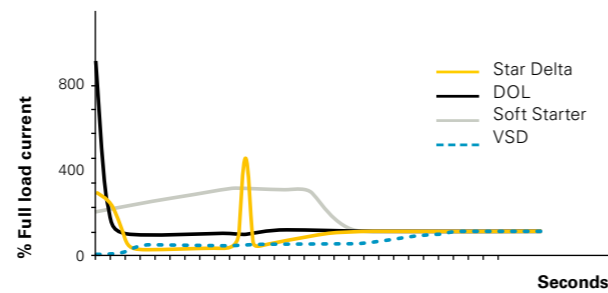

### A high and stable power factor

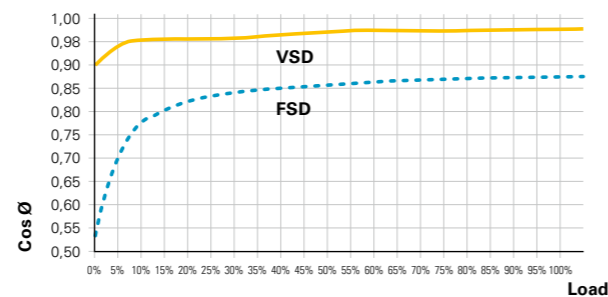

Indirect savings also influence your bottom line:

- Fewer stops and starts improve process stability, resulting in a more reliable production process.
- Low starting current: no peak at start-up, and no need to oversize your electrical equipment and starter.
- High power factor of 0.99: no penalties from utility companies, and no extra investment to correct the Cos Phi.
- EMC tested and certified: no influence of external sources and no emissions to other equipment.

# Optimize your network

Take advantage of the flexibility of the ZD by optimizing your installation and making significant cost savings.

## Need air for peripherals?

Molding machines in a PET blowing operation are often surrounded by an array of peripheral equipment. These include cappers, labelers and instrumentation, all of which require a reliable supply of high-quality compressed air. Before you automatically reach for the order book to purchase an extra stand-alone compressor, consider the Atlas Copco solution.

A ZD Xtendplus compressor comes with a larger model screw compressor to handle medium pressure in your production line, in addition to feeding the 40 bar booster. This approach avoids the high cost of an extra stand-alone compressor. And if you choose the VSD version of a ZD Xtendplus compressor you can achieve further energy savings.

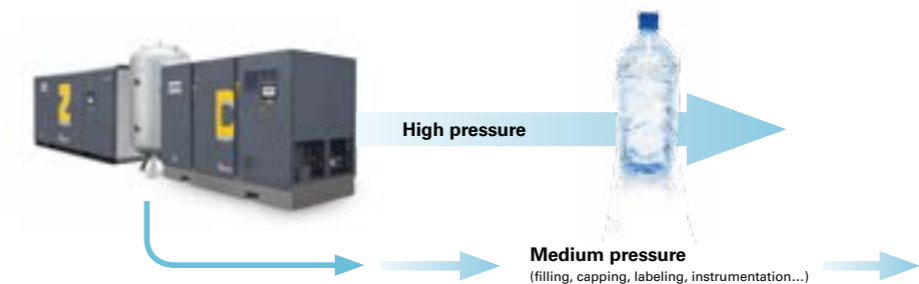

## Want to use recovered air?

These days an air recovery system is a common sight alongside a blow molding machine. It makes good economic sense, as the recovered air can be re-used for both pre-blow and reinjection. If reinjection is a key goal for your company, then we recommend

our ZD Xtend RI compressors. They are available in both fixed speed and VSD versions, are perfectly adapted to reinjection, and allow you to save substantial amounts of energy – and money.

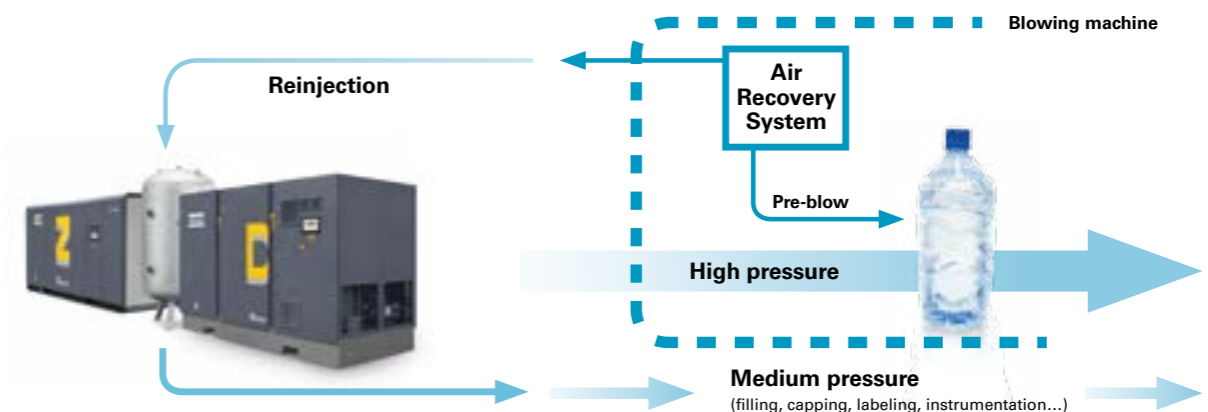

Example of savings with reinjection:

- 13 kW/h per 100 m<sup>3</sup> re-injected at 10 bar with ZD VSD.
- 11 kW/h per 100 m<sup>3</sup> re-injected at 10 bar with ZD Fixed Speed.

The ZD range differs from the standard range with the insertion of a medium pressure vessel (10 bar) between the Z and D. This allows you to separately adapt the size of the Z and D depending on the flow you require.



## Manage your networks

By combining networks, you can optimize your installation and save on investment, maintenance and related energy costs. With minimal adaptations you can manage your medium pressure and high pressure networks separately. Our specialist can make a detailed study on the optimal solution for you and a simulation of the possible savings.

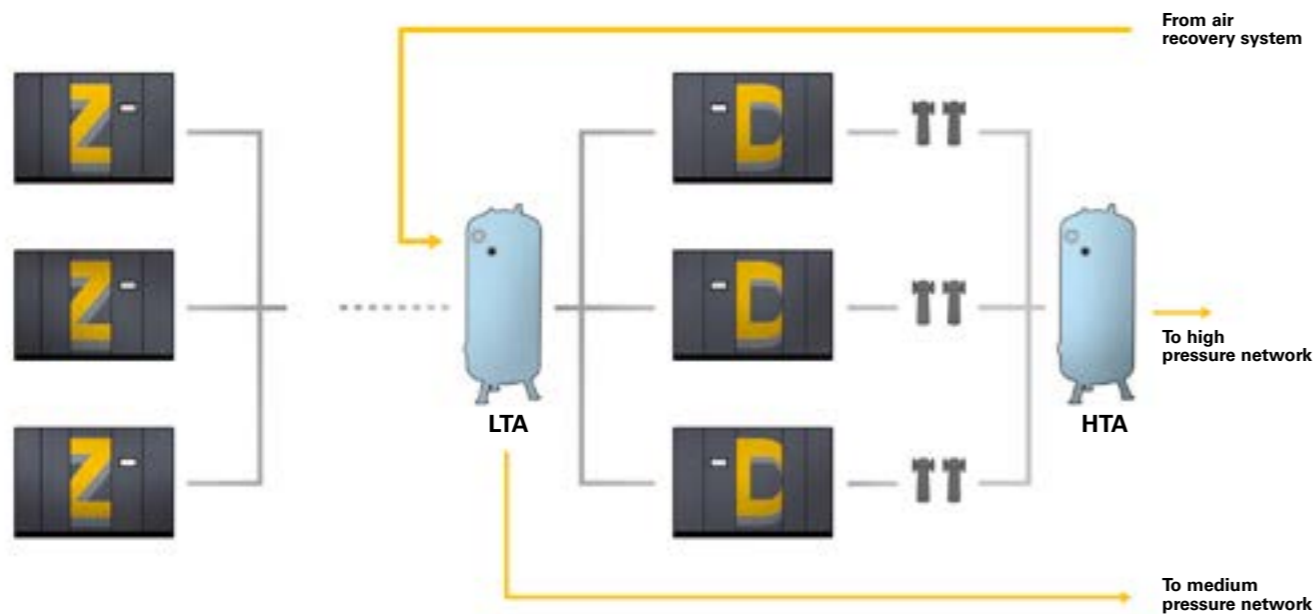

## Closer control through advanced technology

In large multi-compressor installations, technology can bring solutions in terms of energy savings and lower maintenance costs.



ES control is able to control several machines. It guarantees that the running hours are equal across all machines in the same group. This means fewer maintenance visits and reduced maintenance costs.



If remote monitoring is required, the communication modules for Modbus and Profibus allow for integration in plant control systems. With the addition of a Combox, the installation can be accessed directly from a PC or an existing management system.

## ZD air-cooled: Silent, easy and safe

A key reason why operators love the ZD is its silence. With an operating noise level of only 76.4 dBA, normal conversations can be held in its immediate vicinity. Further reasons why the ZD is greatly appreciated are its easy operation and accessible maintenance.

### Plug-and-play installation



- Easy to maneuver with a forklift truck.
- Install on a normal floor without special foundations.
- Everything provided: no hidden surprises or extra costs.
- Easy and quick to relocate if necessary.

### Reduced noise & vibration



- Silencing canopies.
- Absence of vibration.
- Conforms to stringent noise legislation.
- Comfortable for operators and nearby workers.
- Eliminates the need and cost for a separate compressor room.

### Safe and secure



- Key-locked canopies for access only by authorized personnel.
- All operations at human height; no need to climb.
- Easy, safe access for maintenance.

### Easy operation



- A single start/stop button
- The Elektronikon<sup>®</sup> monitoring system:
  - Keeps you fully informed of the status of the compressor's performance.
  - Informs you of the maintenance operations to be performed.
  - Provides alarms and safety shutdowns.
  - Can be connected to a remote computer, enabling you to monitor the status of the compressor from a distance.



## Peace of mind

Atlas Copco does not just offer the most reliable and efficient compressors; we can take responsibility for your entire compressed air system to provide you with best-in-class air. Choose from a wide range of Atlas Copco after sales products and services that will have your ZD compressor performing at its best for years to come. Qualified Atlas Copco support is available in over 170 countries.



### Genuine Parts

Don't put the quality of your investment in danger by buying parts that are not manufactured according to Atlas Copco's standards of excellence. Only Atlas Copco genuine parts can deliver our well-known quality, durability and low energy.

### Service Plan

Choose a Total Responsibility, Preventative Maintenance or Inspection Plan to get the scheduled maintenance to keep your compressor operating trouble free.

### AIRConnect™

Monitor the performance of your compressors from your desk, or let your local Atlas Copco center do it for you. With AIRConnect™, you can check your compressed air system online, receive warning indications and take preventive action in order to avoid downtime.

### Audits

Atlas Copco can make a complete diagnosis of your compressors with the AIRSCAN® system. This allows you to maximize energy savings and investments by improving your complete installation.



## A complete scope of supply

The ZD air-cooled compressor comes as a total solution, without any hidden surprises. Do not hesitate to contact us for any specific request especially for complete adaptations of your LP and HP networks or for energy saving calculations.

### Standard options

- 45 bar outlet pressure
- Dew point indicator

### Accessories

- 40 bar refrigeration dryer
- Pressure vessels
- 40 bar filters

## Technical data

### True performance

The technical data for our machines are measured according to ISO 1217 latest edition, so you always see the real capacity you will receive, not a theoretical airflow that ignores system leakages. This means you get the optimum machine for your process, which leads to substantial benefits and reduced costs.

### Table of data

Model	Pressure bar(e)	Pressure psig	Capacity (*) l/s	Capacity (*) m³/h	Capacity (*) cfm
<b>ZD air-cooled 50 Hz</b>					
ZD 800-50 air-cooled	40	580	220	702	466
ZD 1000-50 air-cooled	40	580	260	936	551
ZD 1200-50 air-cooled	40	580	327	1177	693
<b>ZD air-cooled 60 Hz</b>					
ZD 800-60 air-cooled	40	580	236	850	500
ZD 1000-60 air-cooled	40	580	282	1015	598
ZD 1200-60 air-cooled	40	580	312	1123	661
<b>ZD 1200 VSD air-cooled</b>					
ZD 1200 VSD air-cooled	40	580	174 to 311	626 to 1119	369 to 659

(\*) Performance measured according to ISO 1217, ed. 3, Annex C 1998.

#### Reference conditions:

- Inlet pressure: 1 bar(e)
- Relative air humidity: 0%
- Air inlet temperature: 20°C
- Nominal effective working pressure: 40 bar





### **Driven by innovation**

With more than 135 years of innovation and experience, Atlas Copco will deliver the products and services to help maximize your company's efficiency and productivity. As an industry leader, we are dedicated to offering high air quality at the lowest possible cost of ownership. Through continuous innovation, we strive to safeguard your bottom line and bring you peace of mind.



### **Building on interaction**

As part of our long-term relationship with our customers, we have accumulated extensive knowledge of a wide diversity of processes, needs and objectives. This gives us the flexibility to adapt and efficiently produce customized compressed air solutions that meet and exceed your expectations.



### **A committed business partner**

With a presence in over 170 countries, we will deliver high-quality customer service anywhere, anytime. Our highly skilled technicians are available 24/7 and are supported by an efficient logistics organization, ensuring fast delivery of genuine spare parts when you need them. We are committed to providing the best possible know-how and technology to help your company produce, grow, and succeed. With Atlas Copco you can rest assured that your superior productivity is our first concern!

