

# ***OIL-FREE POSITIVE DISPLACEMENT SCREW BLOWERS***

ZS 18-315 (18-315 kW / 24-422 hp)

ZS 18-355 VSD (18-355 kW / 24-475 hp)



*Atlas Copco*





The control panel features a color LCD screen displaying 'Compressor Status' with a pressure reading of '1.2 bar' and '121.6' in a blue font. Below the screen are several touch-sensitive icons. A prominent yellow and red emergency stop button is located below the screen. The background of the panel has a repeating pattern of the website 'www.atlascopco.com'.

**ZS 75 VSD**

## ***PROVEN TECHNOLOGY IN A LEADING DESIGN***

Low pressure compressed air is the backbone of many production processes. The ZS is the latest addition to Atlas Copco's air blowing solutions, manufactured to the highest standards of quality and reliability.



*Atlas Co*



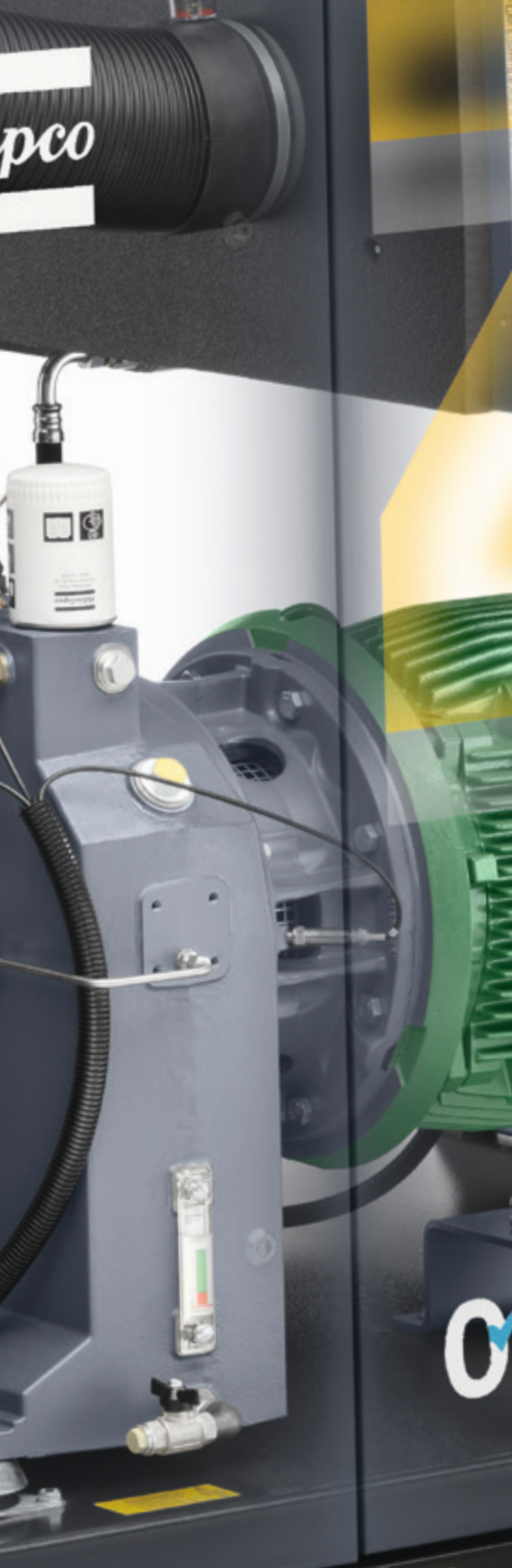

## Keeping your process up and running

A reliable supply of compressed air is critical to ensure process continuity. Incorporating Atlas Copco's proven screw technology and long standing internal engineering practices, the ZS guarantees exceptional reliability. Designed, manufactured and tested in accordance with ISO 9001 certification, the unique ZS stands for uninterrupted production.

## Driving down energy costs

Energy costs can amount to 80% of the Life Cycle Costs of a blower. The ZS range reduces energy costs by an average of 30% when compared to lobe technology. The integrated Variable Speed Drive (VSD) technology offers extra energy savings by automatically tuning the compressed air flow precisely to the air demand.

## Easy installation

Delivered ready for use, ZS+ VSD blowers come as all-in-one packages including a PLC based Elektronikon® controller, integrated converter, forklift slots, check valve, air filter, blow-off valve and silencer. The complete scope of supply eliminates the need for extras and reduces installation to an absolute minimum, saving you time and money.

## Protecting your reputation and production

In virtually any application, oil contamination of the air supply causes serious productivity issues and increases costs. As the first manufacturer to receive ISO 8573-1 CLASS 0 (2010) certification for its oil-free air blowers, Atlas Copco has set a new standard in air purity. Focusing on the protection of critical applications as well as today's increasing quality demands, Atlas Copco offers TÜV-certified 100% oil-free air.

## Assuring your peace of mind

Through continuous investment in our competent, committed and efficient service organization, Atlas Copco ensures superior customer value by maximizing productivity. With a presence in over 170 countries, we offer professional and timely service through interaction and involvement. Uptime is guaranteed by dedicated technicians and 24/7 availability.



## ***A COMPLETE PACKAGE FOR ALL YOUR APPLICATIONS***

Built to ensure complete product safety, ZS blowers guarantee a continuous, highly reliable, energy-efficient and 100% oil-free air supply for years on end in all your applications at the lowest possible cost.



### **Wastewater treatment**

- Lowest aeration blower energy cost, representing 70% of the total operational cost.
- Low downtime and low maintenance cost thanks to innovative screw blower technology.
- Very wide flow and pressure operational range.

### **Pneumatic conveying – dilute phase**

- Lowest energy cost, representing up to 80% of the blower life cycle cost.
- Low downtime and low maintenance cost thanks to innovative screw blower technology.

### **Fermentation**

- Lowest energy cost, representing up to 80% of the blower life cycle cost.
- Low downtime and low maintenance cost thanks to innovative screw blower technology.
- Very wide flow and pressure operational range.

### **Non-woven textile**

- Adjustable flow in order to influence fiber characteristics.
- Energy-efficient blowers to come to the lowest operational cost of this 24/7 continuous process.
- Point-of-use installation without noise-preventing measures.



# CLASS 0: THE INDUSTRY STANDARD

Oil-free air is used in all kinds of industries where air quality is paramount for the end product and production process. These applications include food and beverage processing, pharmaceutical manufacturing and packaging, chemical and petrochemical processing, semiconductor and electronics manufacturing, the medical sector, automotive paint spraying, textile manufacturing and many more. In these critical environments, contamination by even the smallest quantities of oil can result in costly production downtime and product spoilage.

## First in oil-free air technology

Over the past sixty years Atlas Copco has pioneered the development of oil-free air technology, resulting in a range of air compressors and blowers that provide 100% pure, clean air. Through continuous research and development, Atlas Copco achieved a new milestone, setting the standard for air purity as the first manufacturer to be awarded ISO 8573-1 CLASS 0 certification.

## Eliminating any risk

As the industry leader committed to meeting the needs of the most demanding customers, Atlas Copco requested the renowned TÜV institute to type-test its range of oil-free compressors and blowers. Using the most rigorous testing methodologies available, all possible oil forms were measured across a range of temperatures and pressures. The TÜV found no traces of oil at all in the output air stream. Thus Atlas Copco is not only the first compressor and blower manufacturer to receive CLASS 0 certification, but also exceeds ISO 8573-1 CLASS 0 specifications.

CLASS	Concentration total oil (aerosol, liquid, vapor) mg/m <sup>3</sup>
0	As specified by the equipment user or supplier and more stringent than class 1
1	< 0.01
2	< 0.1
3	< 1
4	< 5

Current ISO 8573-1 (2010) classes (the five main classes and the associated maximum concentration in total oil content).



# ON AVERAGE 30% ENERGY SAVINGS WITH ZS SCREW BLOWERS OVER CONVENTIONAL LOBE BLOWERS

1

## Gearbox

- Compared to lobe technology, screw technology does not require belt and pulley replacement.
- Reduced maintenance costs and increased uptime.

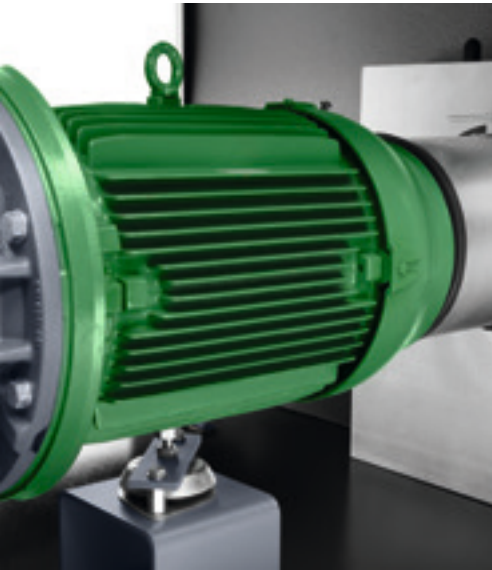

2

## TEFC high-efficiency IE3/NEMA

Even in dusty and humid environments, the TEFC high-efficiency IE3/NEMA premium motor offers assured operation.



3

## State-of-the-art oil-free screw element

- Incorporating acclaimed screw technology, years of experience and innovation.
- Precision timing gears for proven reliability, safe operation and increased uptime.
- Industry proven element coating for closer tolerances and increased lifetime.

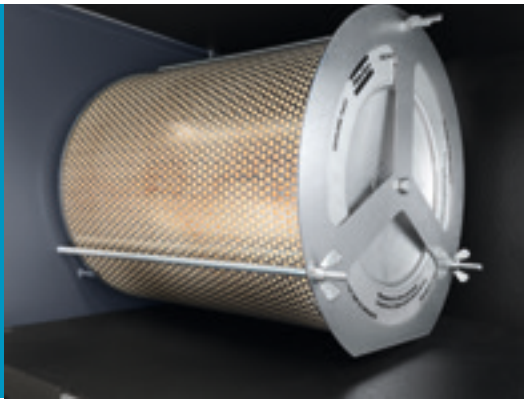

4

### Air inlet filter

The lifetime of the blower is increased by filtering particles up to  $3\mu$  at a performance of 99.9%.

5

### Rain canopy option

Optional rain canopy available for outdoor applications.

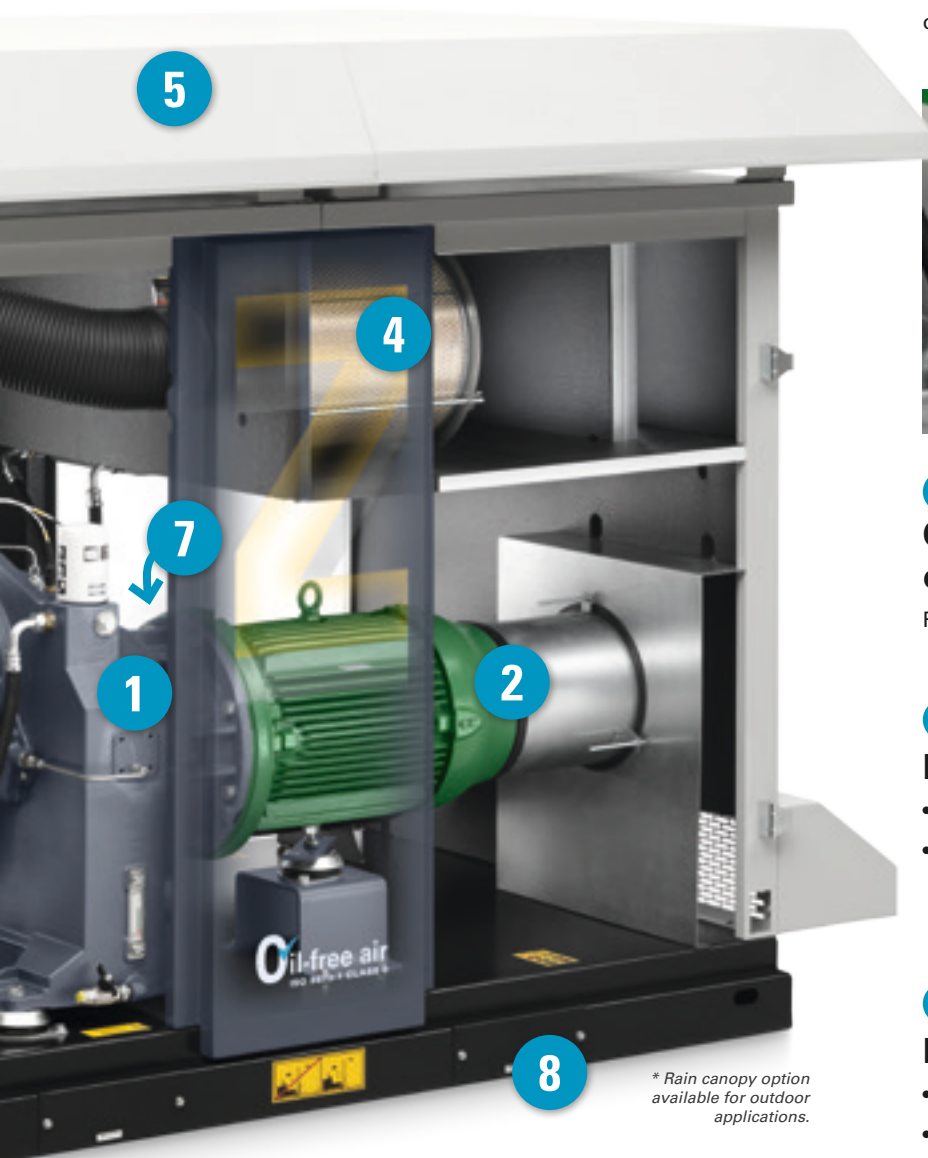

6

### Check valve & pilot operated valve

Reliable, safe and broad operation area.

7

### Discharge pulsation damper

- Eliminating the need for external silencer.
- Without damping material suitable for sensitive applications (e.g. food & beverage industry, pharma, pneumatic conveying, etc.)

8

### Base frame with forklift slots

- Simple, time-saving installation.
- Reduced start-up costs.

9

### ZS Interface-Box (ZS-IB)\*

- Safeguards your investment.
- Ensures maximum machine safety and easy networking.
- Facilitates quick and smooth commissioning.
- Monitors all parameters to ensure maximum reliability for your blower installation.

*\* For versions without electrical cabinet.*





# INCREASE YOUR SAVINGS WITH THE INTEGRATED VARIABLE SPEED DRIVE SYSTEM

1

## Dedicated variable speed motor

- With very wide speed range to meet flexible air demand.
- With bearing current protection and optimized motor cooling at lower speeds.



2

## Electrical cubicle with integrated VSD converter

- Proven design integrating all required electrical components for optimum reliability (EMC filter, Variable frequency drive, RFI filter, Elektronikon® controller).
- Reduced installation and start-up cost thanks to complete integration.

2

3



6

5

## Oil system

Longer lifetime of bearings and gears due to lower oil temperature which is achieved by optimum oil system design including an integrated oil pump\*, oil cooler and filter.

*\* Included for certain ranges (please contact your local sales representative for more info).*







3

### Elektronikon® controller

- To ensure maximum machine safety and easy networking, the Elektronikon® system controls both the blower and the integrated converter.
- Monitoring of all parameters to ensure maximum reliability for your blower installation.

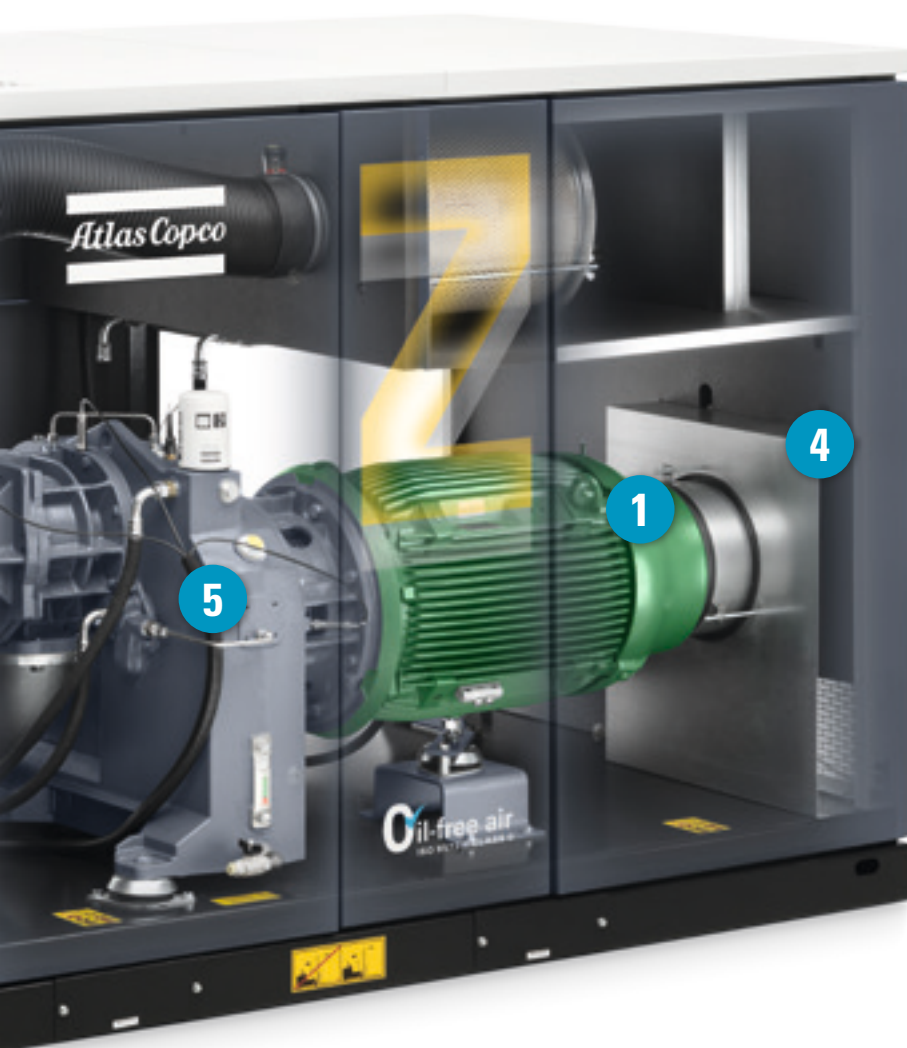

4

### Noise enclosure with internal baffling

- Intelligent internal baffling design coupled with totally enclosed canopy providing reduced sound levels to 72 dB(A) for an improved working environment.
- Reduced installation costs as there is no need for noise insulated rooms and doors.

6

### Continuous SPM (Shock Pulse Measurement) monitoring

- System of the blower element & motor bearings.
- The sensors are connected to the Elektronikon® which is showing the individual vibration levels.
- Alarm and/or shutdown levels can be programmed during commissioning.
- Option.



# MINIMIZE ENERGY COSTS WITH THE ZS SCREW BLOWER

The ZS screw blower was developed in Atlas Copco's drive for innovation and its commitment to sustainable technology, and is on average 30% more energy efficient compared to a traditional 'Roots' type lobe blower.

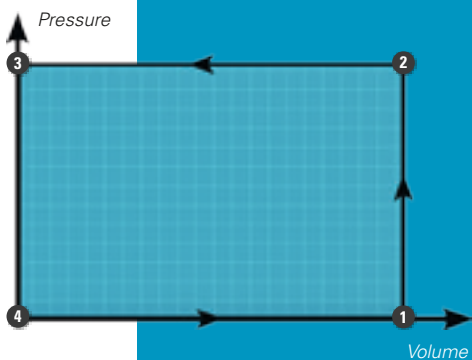
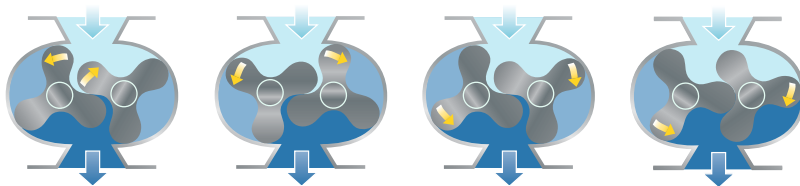

## Energy losses by lobe technology

- 4→1: Suction.** Air enters the compression chamber. The air volume remains constant while the lobe rotors turn.
- 1→2: External compression.** The air is compressed externally due to back-pressure of the connected pipeline.
- 2→3: Discharge.** Air is pushed out into the pipeline.

As shown in the Pressure/Volume diagram, the compression work is represented by the blue area and is proportional to the energy consumed.

○ Thermodynamic energy consumption

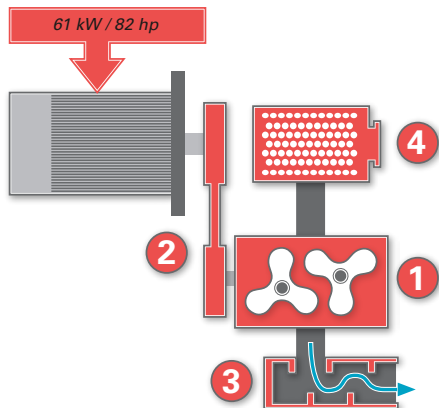

## Energy losses in packaging

High resistance to the internal air flow leads to high pressure drops and increased energy consumption.

- Losses by:
1. External compression
  2. Belt/pulley
  3. Silencer
  4. Inlet filter

To deliver a flow of 1600 m<sup>3</sup>/hr (942 cfm) at a pressure of 0.8 bar(e) (11.6 psig), the tri-lobe blower consumes 61 kW (82 hp) on average.



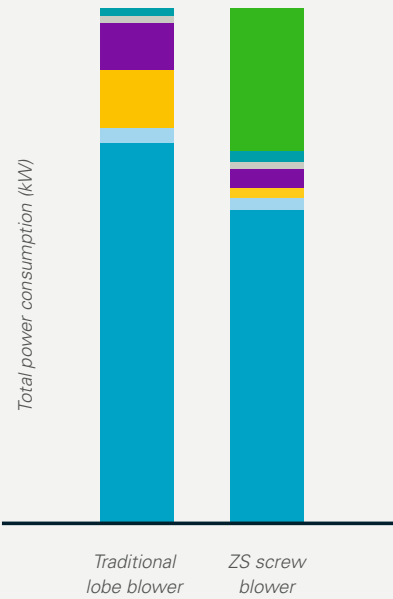

## True package power comparison

- Savings
- Cooling fan
- Motor
- Frequency converter
- Transmission (drive gear vs belt)
- Pressure drops
- Compression

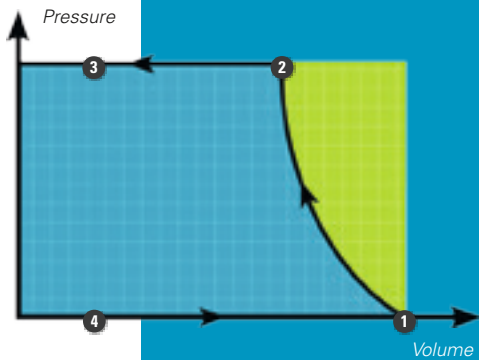
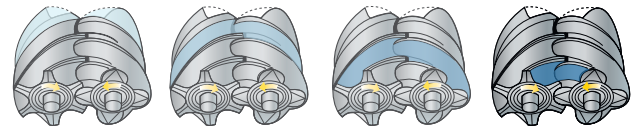

## Energy savings by screw technology

- 4→1: Suction.** Air enters the compression chamber.
- 1→2: Internal compression.** As the rotors move towards each other, the air volume decreases.
- 2→3: Discharge.** Air is pushed out into the pipeline.

As shown in the Pressure/Volume diagram, the compression work is represented by the blue area and is proportional to the energy consumed. The green area represents energy savings of a screw blower compared to a traditional 'Roots' type rotary lobe blower. This is due to the internal compression.

- Thermodynamic energy consumption
- Energy savings

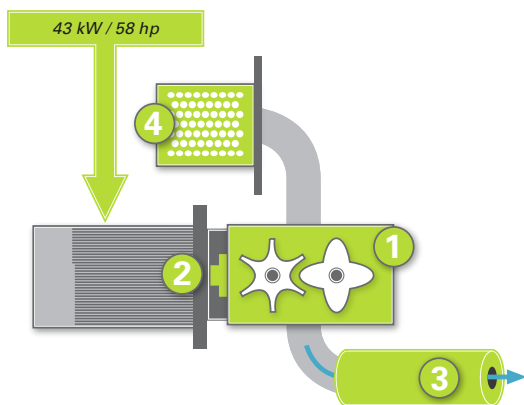

43 kW / 58 hp

## Energy savings by integration

In the ZS screw blower, the internal air flow path is optimized to reduce pressure drops and air turbulence.

Maximum savings by:

1. Internal compression
2. Integrated gearbox
3. Smooth silencer
4. Inlet filter

To deliver a flow of 1600 m<sup>3</sup>/hr (942 cfm) at a pressure of 0.8 bar(e) (11.6 psig), the screw blower consumes 43 kW (58 hp) on average.

SCREW

# VSD: DRIVING DOWN ENERGY COSTS

Over 80% of a blower's lifecycle cost is taken up by the energy it consumes. Moreover, the generation of compressed air can account for more than 40% of a plant's total electricity bill. To cut your energy costs, Atlas Copco pioneered Variable Speed Drive (VSD) technology in the compressed air industry. VSD leads to major energy savings, while protecting the environment for future generations. Thanks to continual investments in this technology, Atlas Copco offers the widest range of integrated VSD blowers on the market.

## Profile 1



- 64% of all installations
- Factory working 24 hrs/day: low demand at night & high demand during the day

## Profile 2



- 28% of all installations
- Factory working 2 shifts/day, no weekend work: erratically varying air demand

## Profile 3



- 8% of all installations
- Factory working 2 shifts/day, no weekend work: typical 'fixed' speed application

## Varying air demand in 92% of all installations

In almost every production environment, air demand fluctuates depending on different factors (time of the day, week or even month). Extensive measurements and studies of compressed air demand profiles show that 92% of all compressor and blower installations have substantial variations in air demand. Only 8% of all installations have a more stable air demand. Tests prove that, even in this case, VSD blowers save energy.

## Energy savings on average up to 35%

Atlas Copco's VSD technology closely follows the air demand by automatically adjusting the motor speed. This results in large energy savings of up to 35%. The Life Cycle Cost of a blower can be cut by an average of 22%. In addition, lowered system pressure with VSD minimizes energy use across your production dramatically.

## Total compressor lifecycle cost

- |   |   |
|---|---|
|  Energy                  |  Investment  |
|  Energy savings with VSD |  Maintenance |

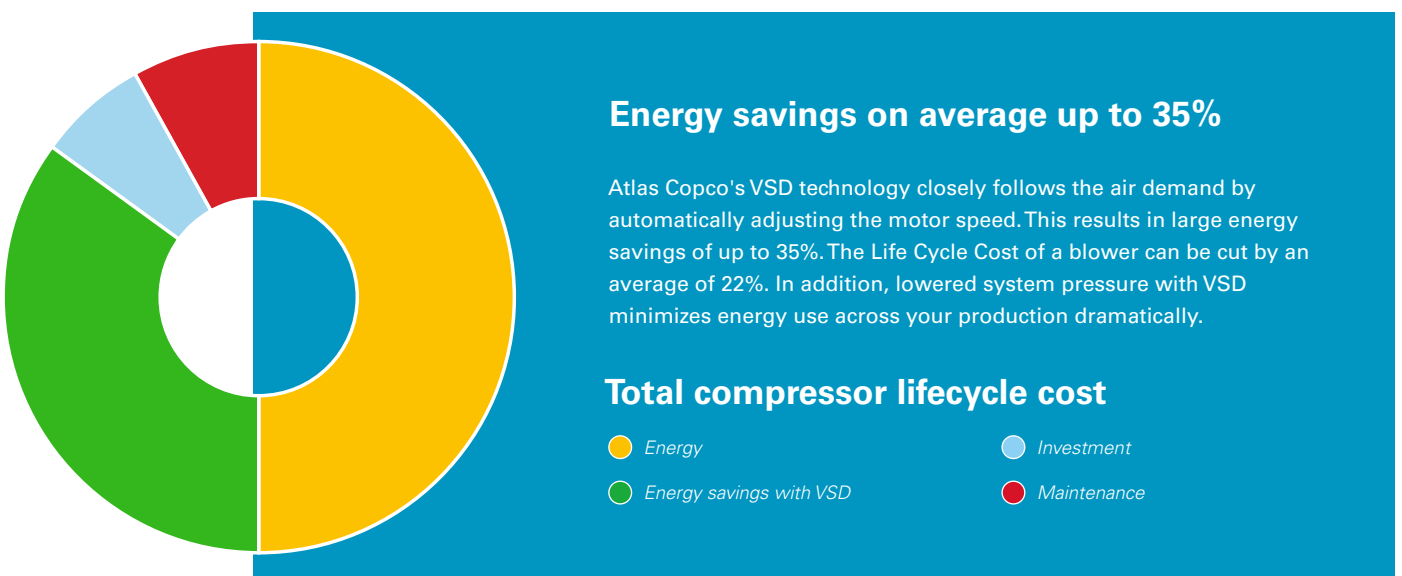



# ES – FULLY OPTIMIZED SYSTEM

A properly managed compressed air network will save energy, reduce maintenance, decrease downtime, increase production and improve product quality. Atlas Copco's ES central controllers are the most efficient way to monitor and control multiple blowers simultaneously as well as dryers and filters. An ES controller offers one central point of control for your whole compressed air network, ensuring all blowers provide optimum performance for your process. The result is a completely dependable and energy efficient network, giving you peace of mind and keeping your costs to a minimum.



## Built-in intelligence

- Improved user-friendliness: 5.7" color display with clear pictograms for easy readout.
- Monitoring of running conditions and graphical indication of the service plan.
- Regulates system pressure within a predefined narrow pressure band.
- Integrated energy savings functions like dual pressure set point, 4 different programmable week schedules.
- Comprehensive icon indications and intuitive navigation.
- 31 different languages including character-based languages.
- Durable keyboard to resist tough treatment in demanding environments.
- Internet-based blower visualization using a simple Ethernet connection.
- Remote control and advanced connectivity functions.



## SMARTLink\*: Data Monitoring Program

- A remote monitoring system that helps you optimize your compressed air system and save you energy and cost.
- It offers you a complete insight in your compressed air network and anticipates on potential problems by warning you up-front.

*\* Please contact your local sales representative for more information.*

# CHOOSE THE MOST SUITABLE UNIT FOR YOUR APPLICATION

With the ZS range, Atlas Copco provides the most suitable scope of supply for both replacements and new installations by offering basic, standard and premium variants.

## Scope of supply

Air circuit	Air intake filter Flexible air intake pipe Coated screw element Starting/safety valve Check valve Discharge pulsation damper Outlet air flange
Oil circuit	Supplied oil-filled Completely pre-piped oil circuit Oil pump Oil coolerz Oil filter Built-in oil breather system
Connections	ANSI or DIN flanges
Electrical components	Pre-mounted TEFC IP55 motor
Framework	Base frame with forklift slots
Mechanical approval	ASME or CE approval

## Additional features & options

	ZS without electrical cabinet	ZS with electrical cabinet
<b>Additional features</b>		
Integrated Variable Speed Drive (VSD)/integrated YD starter	-	✓
Flow control via 4-20 mA (external source)	-	✓
LAN or Internet control/monitoring	✓	✓
Control system (Elektronikon®)	-	✓
EMC filter	-	✓
RFI filter	-	✓
<b>Options</b>		
Wooden case	•	•
Full option motor (anti-condensation heater and PT1000's)	•	•
Variable speed duty motor	•	•
ZS Interface-Box (ZS-IB)	✓	-
Rain canopy	•	•*
SPM	-	•

\* For more information, please contact your local sales representative.

✓: Standard •: Optional -: Not available

## True performance

Atlas Copco's ZS blowers are measured according to ISO 1217, Annex C, latest edition, stipulating the FAD measurement at the outlet of the package, net of all losses. Atlas Copco specifications correspond to the capacity and pressure the customer receives, not to the intake volume of the blower. Differences are substantial.

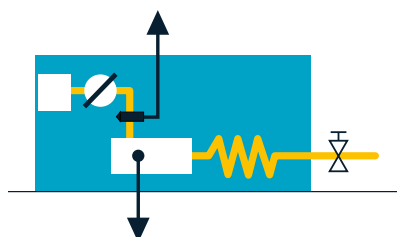

Inlet flow referred to blower element inlet conditions. Seal leakages and inlet losses should not deprive you of the air you paid for.

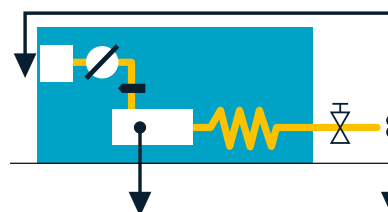

FAD according to ISO 1217, Annex C, latest edition. A ZS blower truly delivers what is promised.





## ***COMMITTED TO SUSTAINABLE PRODUCTIVITY***

We stand by our responsibilities towards our customers, towards the environment and the people around us. We make performance stand the test of time. This is what we call – Sustainable Productivity.



[www.atlascopco.com](http://www.atlascopco.com)

